

ASSEMBLY INSTRUCTIONS

VIRGINIA SOFA COLLECTION 2-SEATER

Please read instructions carefully. Remove all wrapping material and packing from the carton. See hardware and furniture parts list for guidance. Be sure you have all parts before you start to assemble the product. Place all furniture parts on a clean surface, such as carpet or rug to prevent the item from being scratched.

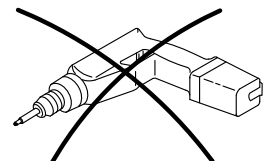
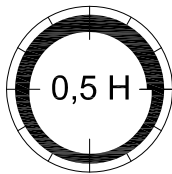
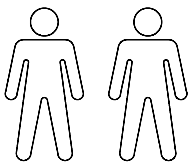
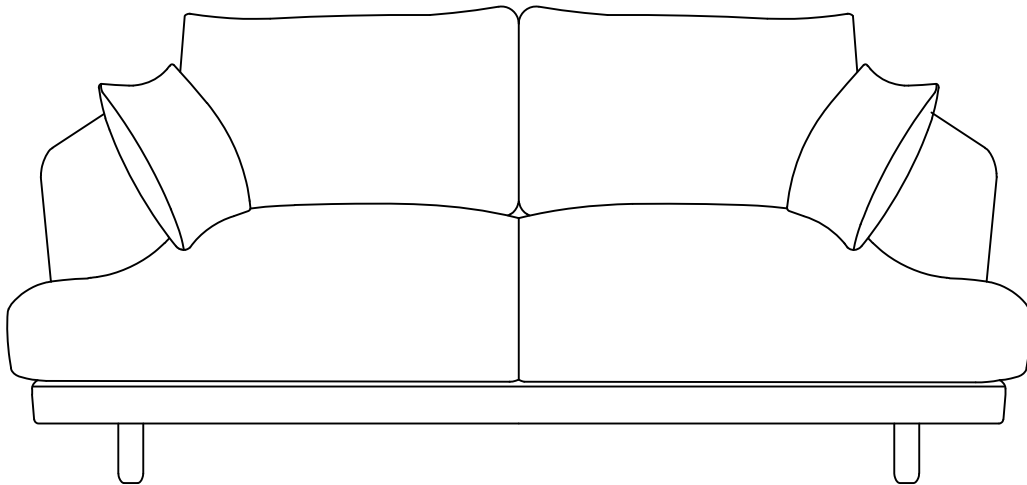

Part list:

1 x Part 1

1 x Part 2

1 x Part 3

2 x Part 4

2 x Part 5

4 x Part 6

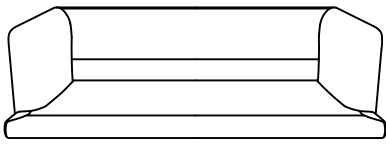

Seat



Seat cushion left



Seat cushion right



Back cushion



Cushion



Legs

Hardware list:

Ax8

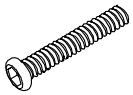

Bolt
M8x38

Bx8

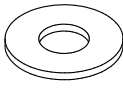

Washer
Ø25

Cx8

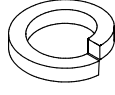

Spring Washer
Ø13

Dx4

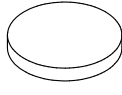

Felt
Ø20mm

Ex1

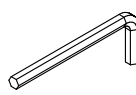



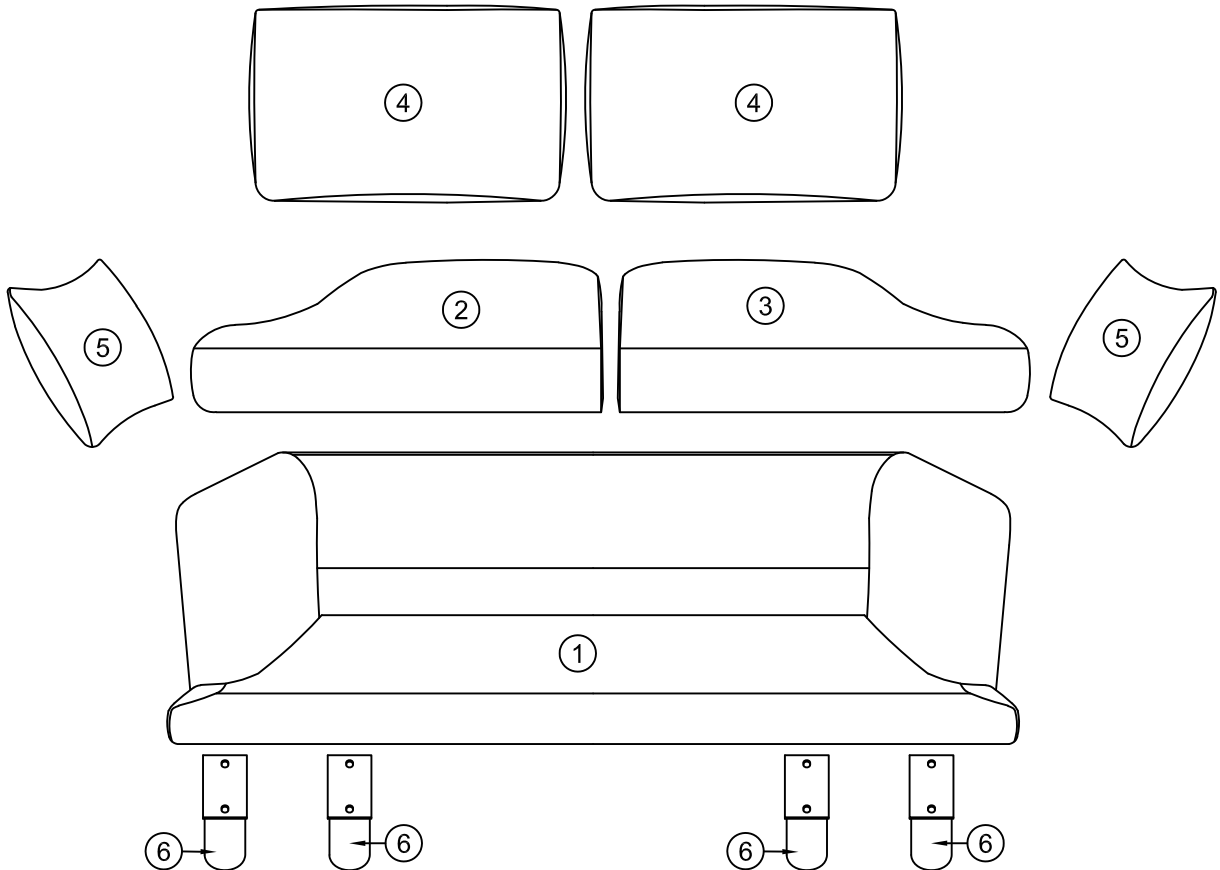

Allen key
5mm

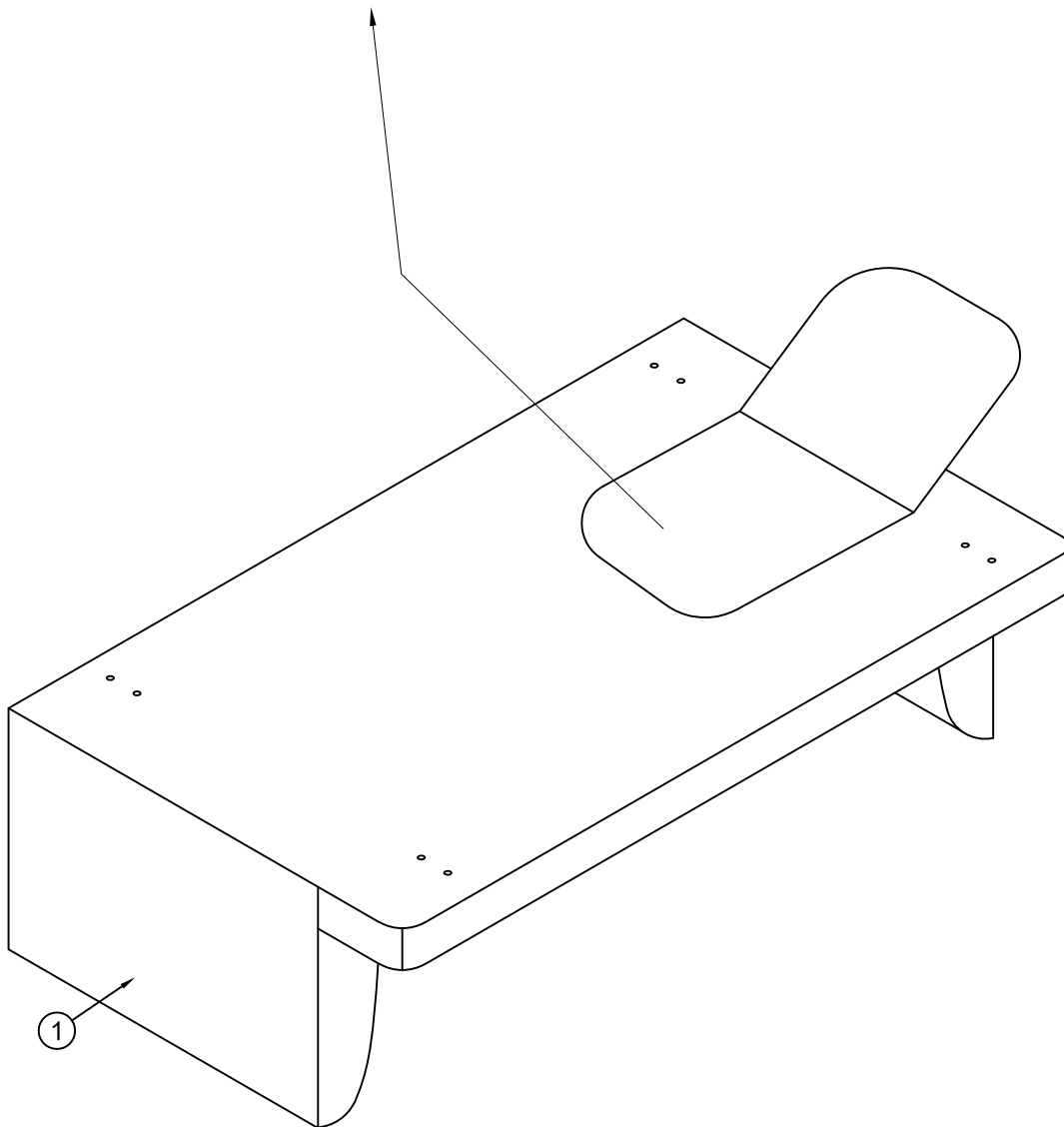
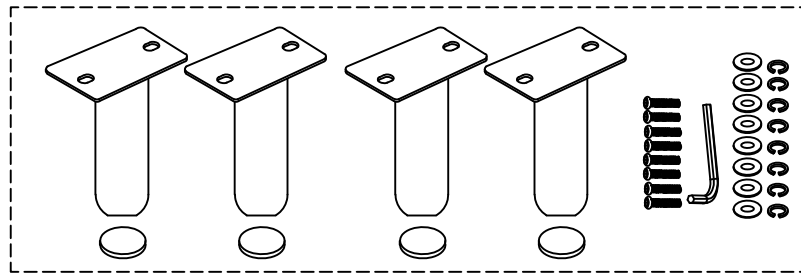

BEFORE TURNING SOFA UPSIDE DOWN, MAKE SURE THE SURFACE BELOW IS CLEAN AND FREE OF DUST. WE RECOMMEND USING TWO PEOPLE TO MOVE THE SOFA

1

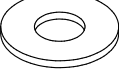
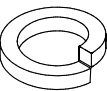

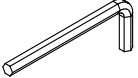
Ax8  M8x38 mm	Bx8  Ø25 mm	Cx8  Ø13 mm	Dx4  Ø20 mm	Ex1  5 mm
--	--	--	--	--

