

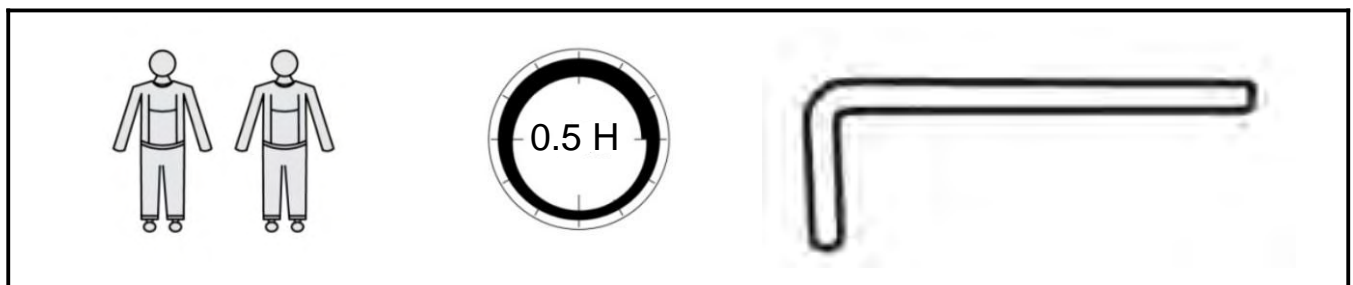

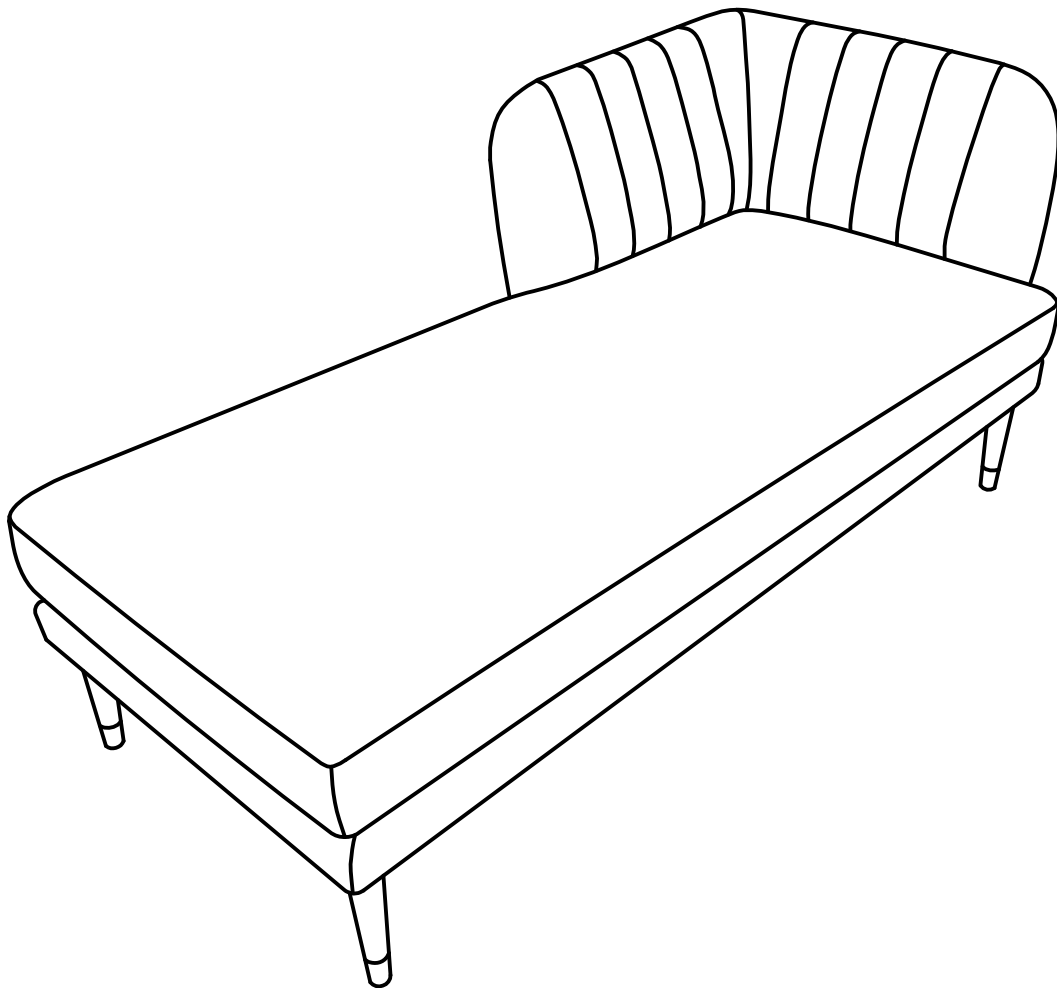

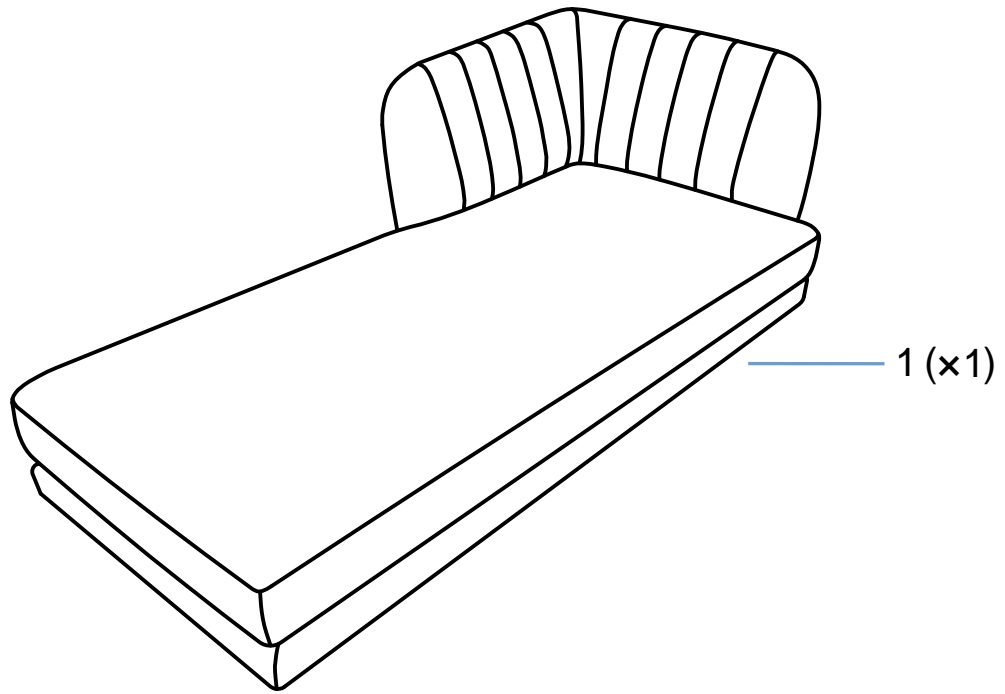

ASSEMBLY INSTRUCTIONS

KENSINGTON - CHAISE

Please read instructions carefully. Remove all wrapping material, samples and packing straps from the carton. See hardware and furniture parts list for guidance. Be sure you have all parts before you start to assemble product. Place all furniture parts on a clean flat surface, such as carpet or rug to prevent from being scratched.

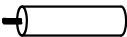

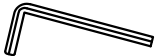

				
A x 4	B x 1	C x 16	D x 1	E x 1

1

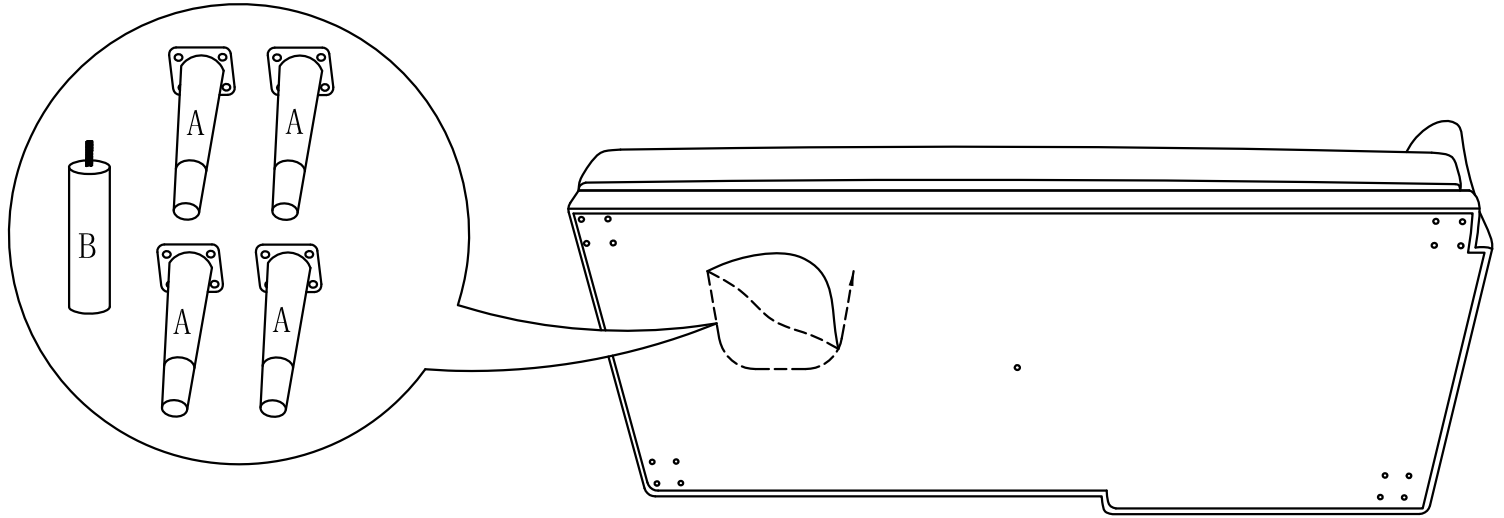

2

